

data sheet: H2G50

Kroepelin GmbH
Gartenstraße 50
D-36381 Schlüchtern

Tel.: 06661 86 0
Fax: 06661 86 39
Mail: sales@kroepelin.com
Web: www.kroepelin.com

Kroepelin
Längenmesstechnik

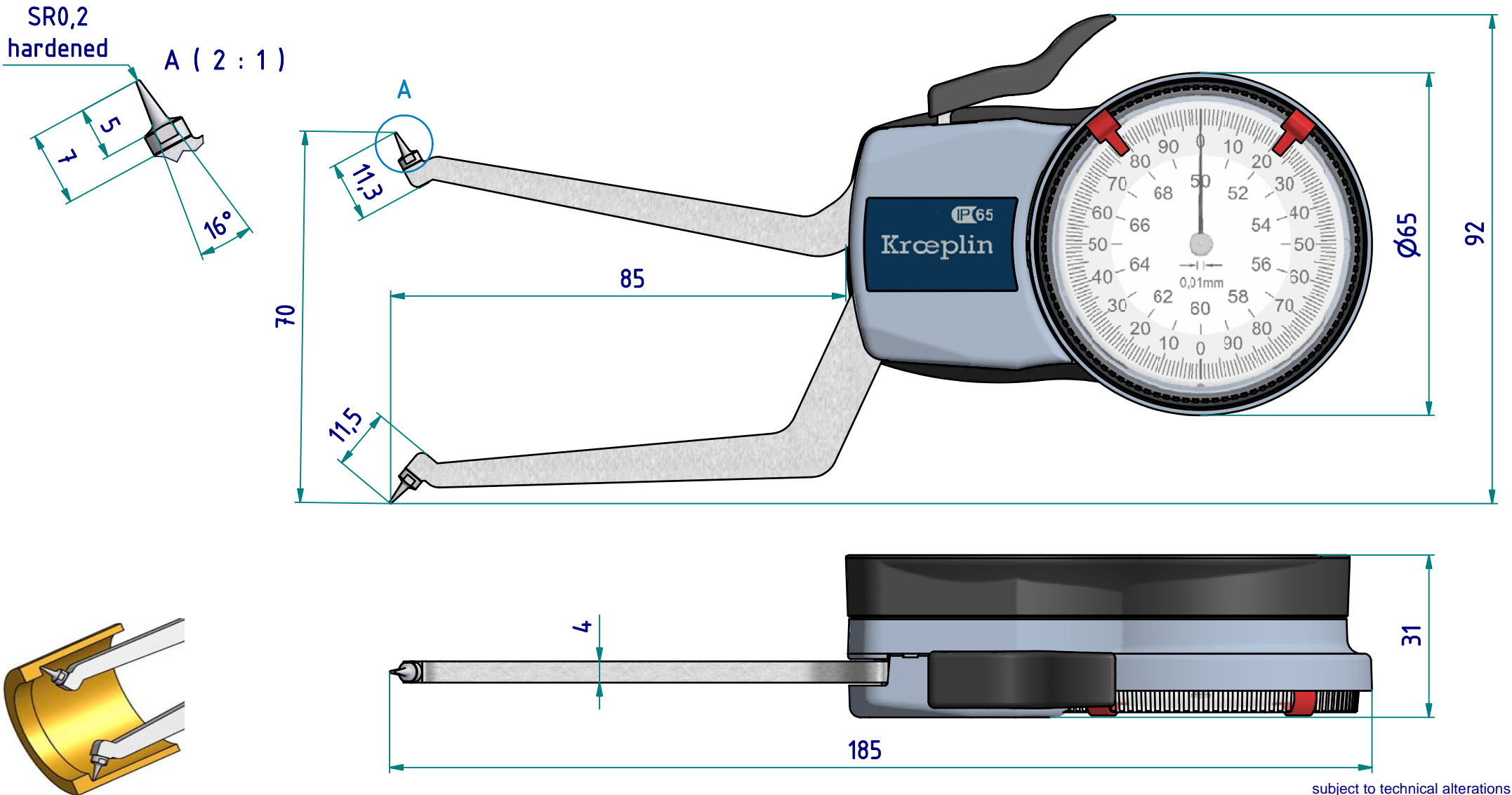

subject to technical alterations

type: H
range: 50 - 70 mm
range of indication: 49,5 - 70,5 mm
digital step: -
scale interval: 0,01 mm
measuring force: 1,1 - 1,6 N
weight: 195 g

acceptable deviations
VDI/VDE/DGQ 2618 Bl. 12.1/13.1)
max. permissible errors "G": 0,03 mm
repeatability "r": 0,01 mm
reference temperature: 20° C
operation temperature: 10° C - 30° C
storage temperature: -10° C - 50° C

scale: 1:1
drawing-nr.: DAB-H2G50_KR_e
date of issue: 08.01.09
name: T.Koenig
revision status:
revision date: